

THE PROPERTY OF THE DRAWING IS ESTABLISHED BY LAW. IT IS FORBIDDEN TO PRODUCE OR SHOW IT TO THIRD PART. WITHOUT A WRITTEN AGREEMENT.

Item	Name	Q.ty
1	CA.JU.8040.1000	1

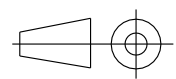
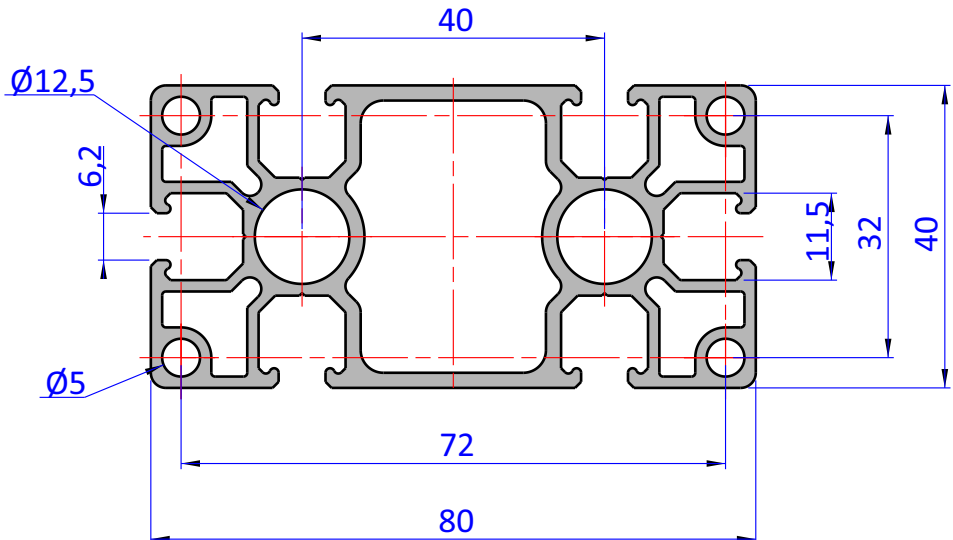
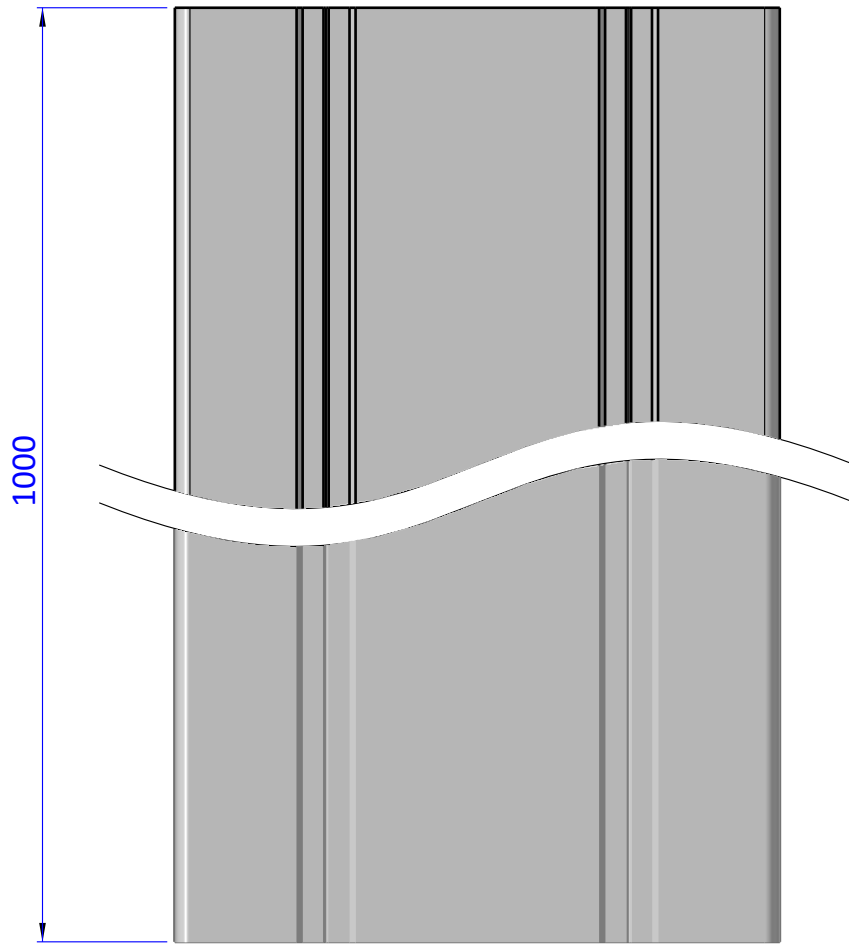

DESIGNED FROM	FPS Automation		REVIEW	A
DATE	11/03/2020	WEIGHT	2,302kg	
CODE	CA.JU.8040.1000			

Format A4
UNI 936-76

GENERAL TOLERANCE
UNI - ISO 2768
CLASSE f

DESCRIPTION
CA.JU.8040.1000